



symmetry[®]
WORK IN MOTION



TENSOR[™]
ALL-IN-ONE TABLE



The all-in-one solution

As your business grows and changes, your workspace should be able to keep up. That's why we created Tensor – one table that can adapt to your changing needs. It's the only table that can expand to support multiple tops on a single base. This allows you to install and reconfigure to fit any space quickly and easily.

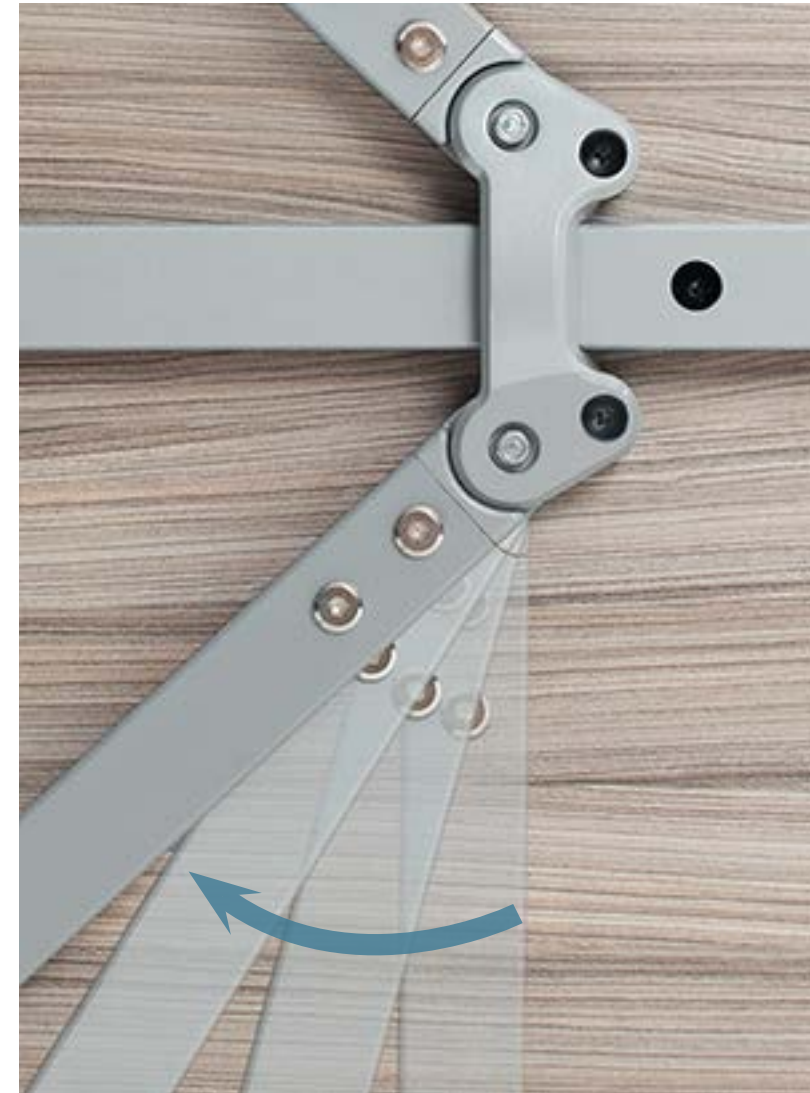

Start here. Go anywhere.

We think simple is better, so we created a table with a straightforward design that installs in less than 10 minutes. We started with the isosceles triangle – an architectural shape used to promote stability. The triangular shapes within Tensor allow it to move to match the width and the depth of your top. With this extensive scalability, you can go from a larger meeting table all the way down to a smaller hospitality table.

Super smart & adap-table

Work should bring people together and foster collaboration. With Tensor, you can meet your dynamic, ever-evolving needs. From individual desks to open concept collaborative spaces, Tensor is the first versatile solution of its kind that can adapt not just to the space but the entire office.



Tensor makes it easy to meet the way you want



Lunch or lounge,
Tensor does it all



The finishing touches

Table Finishes

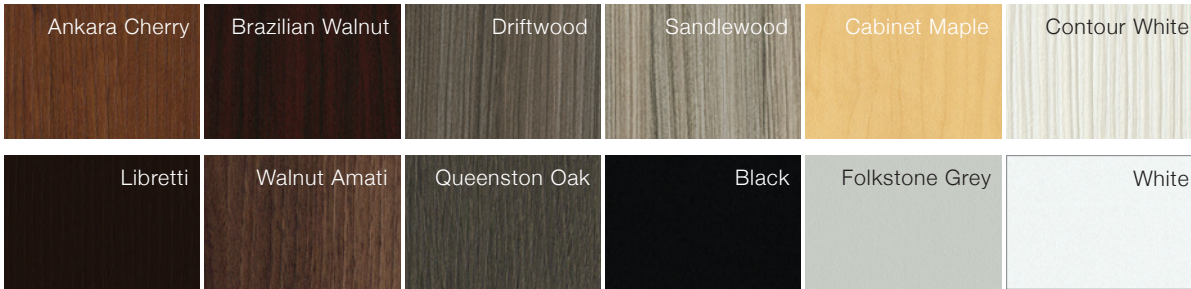

Base Finishes

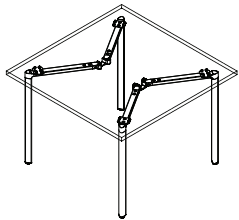
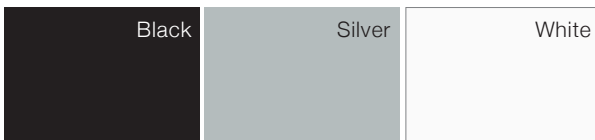

Base Only
Supports Tops
30" - 42" wide

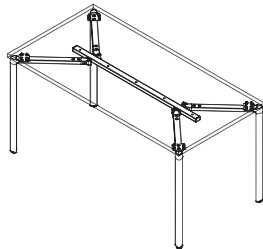

Base + Short Stretcher Bar
Supports Tops
48" - 66" wide

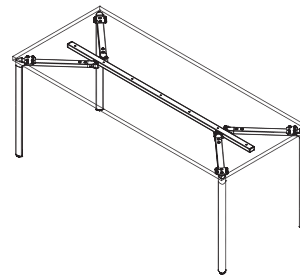

Base + Long Stretcher Bar
Supports Tops
72" wide



Return for L-Shape Desking
Supports Return Tops
36" - 60" wide

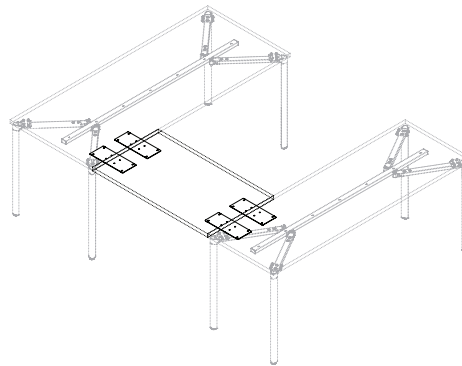

Bridge for U-Shape Desking
Supports Bridge Tops
36" - 60" wide

symmetry[®]